

# Energy-Efficient Multi-Level Amplifier Solutions

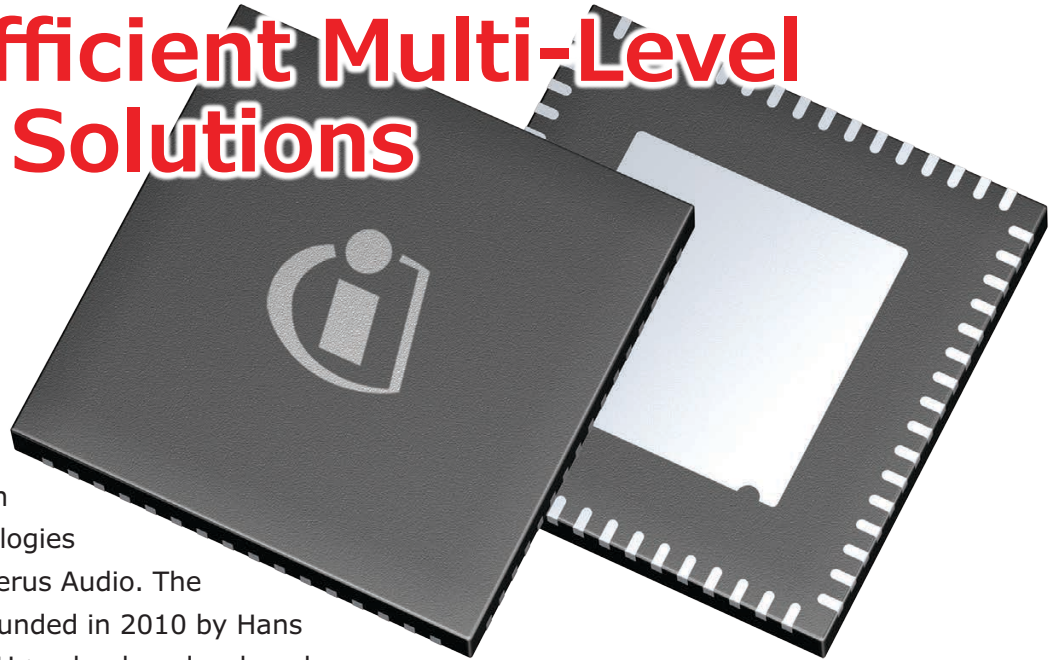

In February 2018, shortly after a successful presentation at the CES show in Las Vegas, NV, Infineon Technologies announced the acquisition of Merus Audio. The Copenhagen-based start-up, founded in 2010 by Hans Hasselby-Andersen and Mikkel Høyerby, has developed a new generation of energy-efficient integrated Class-D amplifier solutions, which stirred the industry's interest. *audioXpress* was already working on this article.

By  
**Ward Maas**  
(The Netherlands)

There are several development goals in the design of Class-D audio amplifiers. A major goal has always been to obtain very efficient high-power amplification. Nowadays, there are many high-power designs, mainly used in pro audio, where that goal clearly has been met. Kilowatts of power at an efficiency higher than 90% are rather common. With the use of switch mode power supplies, these amps even became lightweight.

Another aspect of Class-D development is to improve the amplifier's quality to such a level that it becomes a match (or an improvement) for traditional types of amplifiers. We saw that with the efforts of

the Dutch company Axign and its AX 5689 (see "Axign of Things to Come," *audioXpress*, December 2017). The advantages for any manufacturer of a product that incorporates an audio amplifier are clear: power, efficiency, quality, and cost.

Looking to maximize audio performance and battery playback time for smart home and battery-powered speakers, while minimizing heat and design space, were primary goals for the development of the Merus eximo technology by the Danish company now acquired by Infineon. Since the acquisition, Infineon decided to drop the "eximo" name, now branded simply as multi-level Class D amplifier ICs.

There are market segments where audio amplifier efficiency is much desired. Unfortunately, one of the by-products of that efficiency is electromagnetic interference (EMI) levels that are challenging to solve. There is where Merus Audio differentiated with its multi-level switching technology. An advanced new platform that now allows Infineon to offer solutions for low-power applications that are suitable for products in which efficiency and low EMI—and EMC compliance—are key.

## Multi-Level Amplifiers

The creators of the technology are based in Copenhagen, Denmark, and were able to quickly

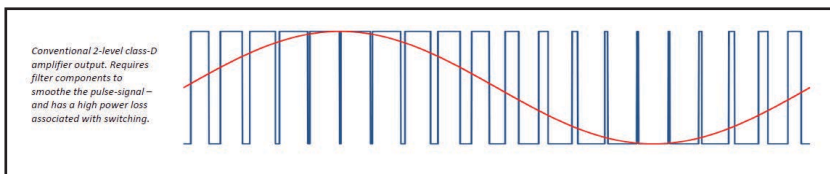

Figure 1: Conventional Class-D output signal

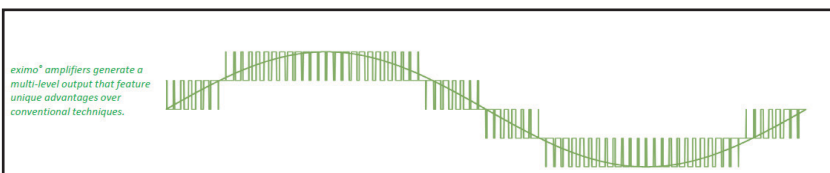

Figure 2: Multi-level amplifier output signal

establish sales offices in the US, Singapore, and Hong Kong. One year following the company's creation, Merus Audio submitted its first patent for the multi-level amplifier topology. In 2014, the company publicly demonstrated the MA12040 amplifier IC at Stanford University and products started sampling to customers in 2015. In 2017, four variants of multi-level amplifier ICs, from 2x 40 W to 2x 80 W were shipping and products from established brands in the US, Europe, and Asia were incorporating the technology.

These amplifiers feature a unique power stage topology with more—but smaller—power transistors to create the amplified output. The power stage generates multi-level modulation patterns of up to five levels, thereby approximating the audio signal much closer to analog signals than conventional Class-D amplifiers.

**Figure 1** shows the conventional two-level output of a Class-D amplifier. The output signal of the multi-level amplifier displayed in **Figure 2** shows the output signal. **Figure 3** and **Figure 4** show the output stages of a conventional Class-D amplifier and a multi-level amplifier.

This multi-level output signal has a few clear advantages. Frequency multiplication is an inherent property of multi-level modulation, which essentially makes the effective switching frequency at the speaker load much higher than the switching frequency of the individual power transistors. This is utilized in Merus amplifiers to significantly lower the switching activity, reducing the power losses associated with each switching event.

**Figure 5** shows how the signal is built up at the switching node in a bridge-tied load (BTL) configuration for one sinusoid cycle. In this case, the speaker load switching frequency is four times the MOSFET switching frequency at the output nodes. Also note that the switching pattern gives rise to three states where complete cancellation of the out-of-band switching residue takes place. This directly translates to a reduction of the ripple current in the audio system output section. With no need to suppress out-of-band switching artifacts, many applications do not require a common-mode applied L-C filter.

The effect of the reduced ripple current is shown in **Figure 6**. When normalized to the ripple current of a traditional Class-D amplifier (red line), 3-level or half bridge (blue line), and 5-level or BTL (black line) modulated output signals exhibit strongly reduced ripple current. Also note the zero states for 3-level and 5-level signals—points at which there is no ripple current. Overall dissipation and power loss are significantly reduced due to the reduced ripple current in external components.

Conventional Class-D amplifiers typically require

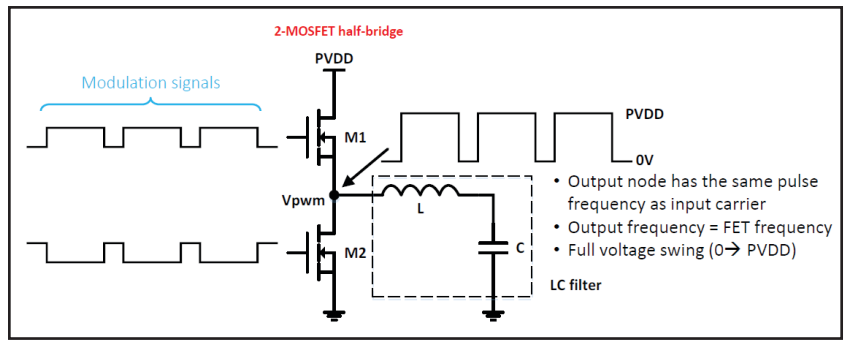

Figure 3: Conventional Class-D output stage

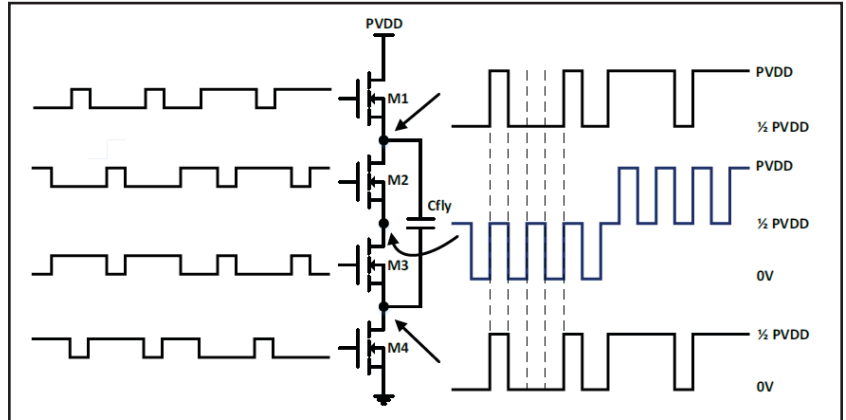

Figure 4: Multi-level amplifier output stage

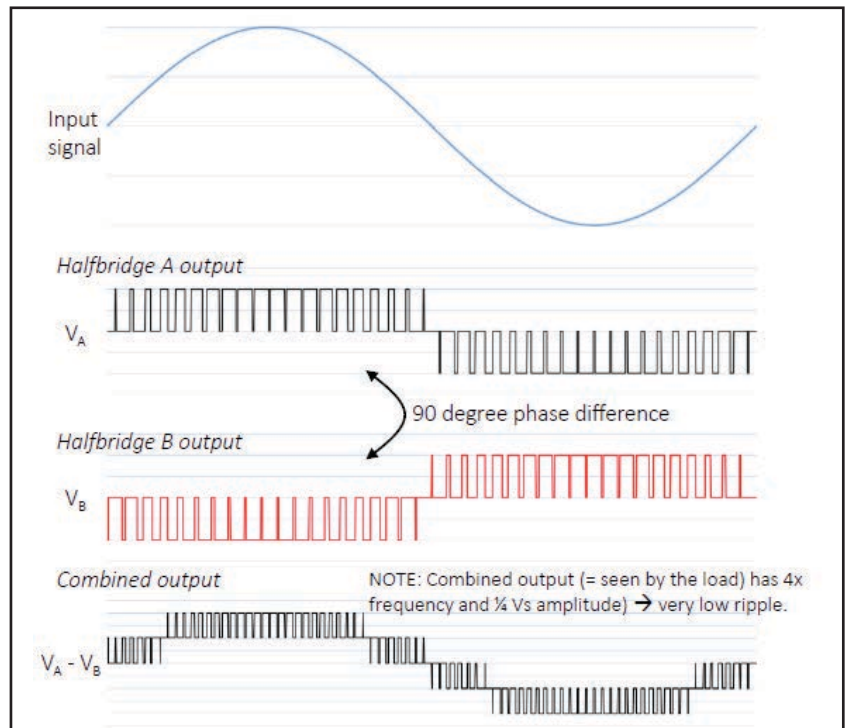

Figure 5: Signal is built up at the switching node in a BTL configuration.

### About the Author

Ward Maas is the owner of Pilgham Audio. He studied electronics, marketing, and amplifier design. During his career in consumer electronics, Ward worked in areas ranging from CD standardization to radio and television to personal GPS navigation. Ward has worked on an extreme low-noise magnetic cartridge preamplifier and several special amplifier products. As the CTO of "Witchworld," a theme park near Amsterdam, he also works with animatronics. He lives in Almere, Netherlands, with his wife and son.

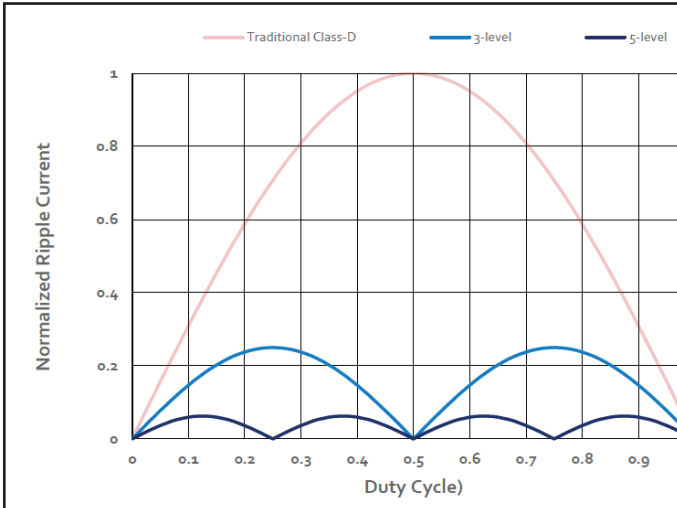

Figure 6: Normalized ripple currents vs. duty cycle

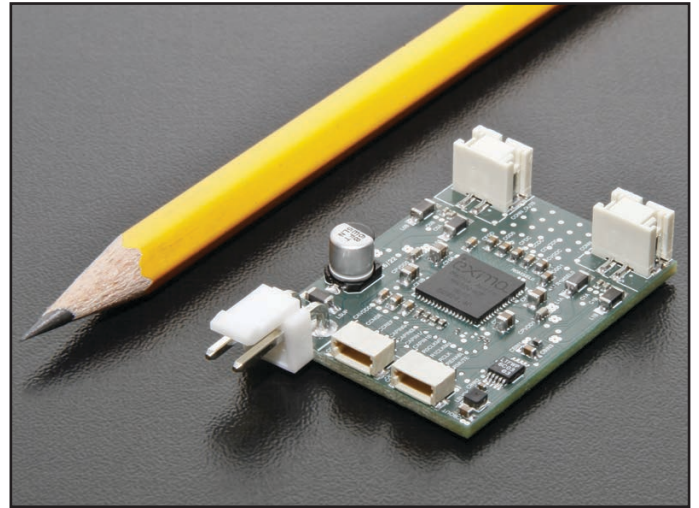

Photo 1: Ultra-compact amplifier design made possible

an L-C output filter to reconstruct the audio waveform before the amplified audio signal reaches the speaker. The filter accounts for a large portion of the size and area for the total amplifier solution as well as for the Bill-of-Materials (BOM) cost.

Multi-level switching significantly reduces the output signal's switching content. Therefore, in most cases, Merus amplifiers can drive speakers directly, without the use of an L-C filter—even in higher-powered applications. This enables ultra-compact solutions (see **Photo 1**) and design freedom in the target application. For smaller audio applications (e.g., mobile phones), an L-C filter is not required due to the low output power level of the audio amplifier.

The multi-level output stage offers great flexibility and allows for the configuring of the amplifier for optimal power performance in many applications. Via a digital control interface, various power modes can be defined by selecting the modulation method and the

switching frequency.

During amplifier operation, the integrated power management algorithm automatically selects the most optimal power mode for a given power level. The seamless transition between power modes ensures that power losses are minimized across the entire output power range while ensuring high audio performance and low EMI.

Multi-level amplifiers incorporate a fourth-order feedback loop. This guarantees excellent audio performance and a robustness against real-world system imperfections (e.g., a non-ideal power supply rail voltage). This feedback loop is fully integrated on-chip. This minimizes the design-in effort by avoiding a time-consuming selection and optimization procedure of the external loop filter components for achieving loop stability and satisfactory performance.

Several integrated protection features ensure that both the amplifier and the speakers are protected from potential damage

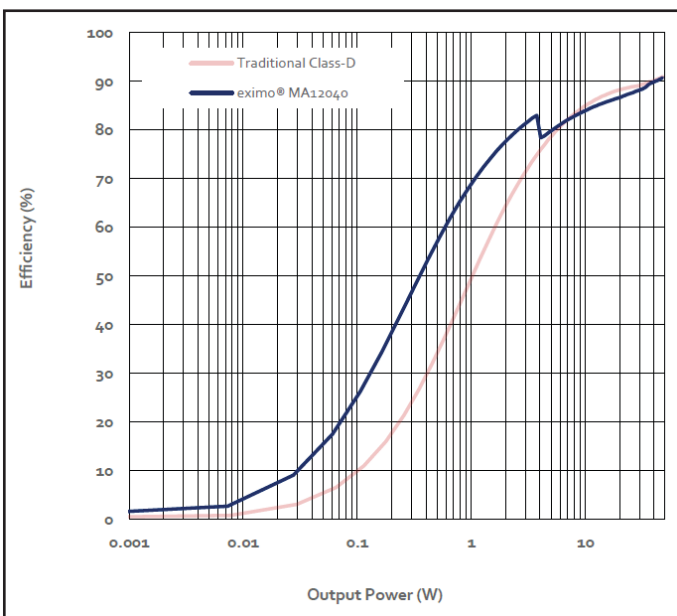

Figure 7: Efficiency vs. output power

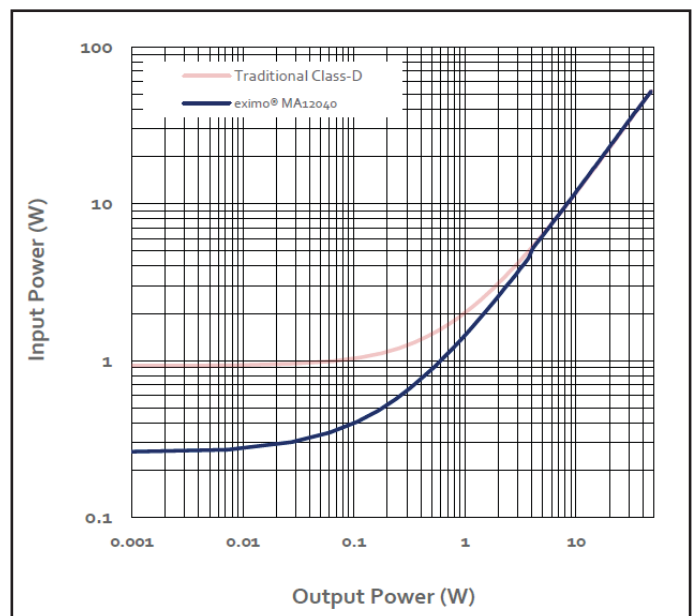

Figure 8: Input power vs. output power



# Multi-level audio amplifiers from Infineon

Guaranteeing best-in-class audio performance and high power efficiency

**These fully integrated IC solutions provide a number of advantages, including:**

- › Small and light - enabling high power delivery in a very small form factor.
- › Very low power losses and cool, heatsink-free operation.
- › EMC compliance without the use of bulky filter components.
- › Reduced bill of materials and cost due to elimination of additional components and complex dynamic rail tracking schemes.
- › High dynamic range.
- › Down to 0.003% THD and low noise.
- › Support for both analog and digital audio input.
- › Highly configurable for tailored performance in individual applications.

Explore the product portfolio to maximize the user experience through audio performance and design freedom!

Find out more on  
[www.infineon.com/audiosolutions](http://www.infineon.com/audiosolutions)





Photo 2: Copenhagen-based Soundboks designed a “portable party speaker,” which was one of the first products to benefit from the MA12070P multi-level amplifier ICs, enabling higher power and longer battery life.

during various fault events. This includes over-current protection circuits, on-chip temperature sensors, and under-voltage supply monitors. All warning and error signals are stored in registers that can be read via the amplifier control bus. A dedicated error pin is also available for hardware error signaling. In general, multi-level amplifiers are designed to keep playing music for as long as possible and only shut down in the event of a non-recoverable error.

### Maximizing Battery Life

For low-power (battery) operation, battery lifetime is undoubtedly very important. Efficiency is mostly specified at high power levels. However, these maximum output levels are hardly ever met in consumer applications. So the efficiency in low

output conditions is the one that has higher influence on battery life. By cutting power losses, multi-level amplifiers enable audio product designers to either extend battery lifetime or reduce the size of the costly Li-Ion battery. As the heat dissipation during typical operation is significantly reduced, heatsinking can also be much smaller. In fact, in most cases the amplifier circuit board will offer sufficient heatsinking capability, even in relatively high-powered applications where other amplifiers would require a dedicated heatsink.

The low heat dissipation leads to a generally cooler operation inside the audio application. This gives a much larger headroom for periods of higher output power (e.g., during music playback at high volume levels). Cooler operation also has an impact on the reliability of the audio application, due to a reduction of thermally accelerated aging of many system components. **Figure 7** and **Figure 8** show the efficiency of the MA12040 IC over power vs. a traditional Class-D amplifier. Certainly, the improvement in low-mid power use is remarkable.

One of the first companies to make use of this technology was Danish company Soundboks (<https://soundboks.com>). The company raised a few eyebrows by presenting the Soundboks 1, the loudest and the largest “portable” Bluetooth speaker. With a battery life of 30 hours, it was presented as the ultimate speaker for outdoor parties and sports and it even comes with a backpack frame to make it truly “portable.” Soundboks 2 (see **Photo 2**), the current product is even louder (122 dB) and has an improved battery life of 40 hours and features two MA12070P ICs. This made it clear that the technology was very much at the top of the Class-D quality efficiency products.

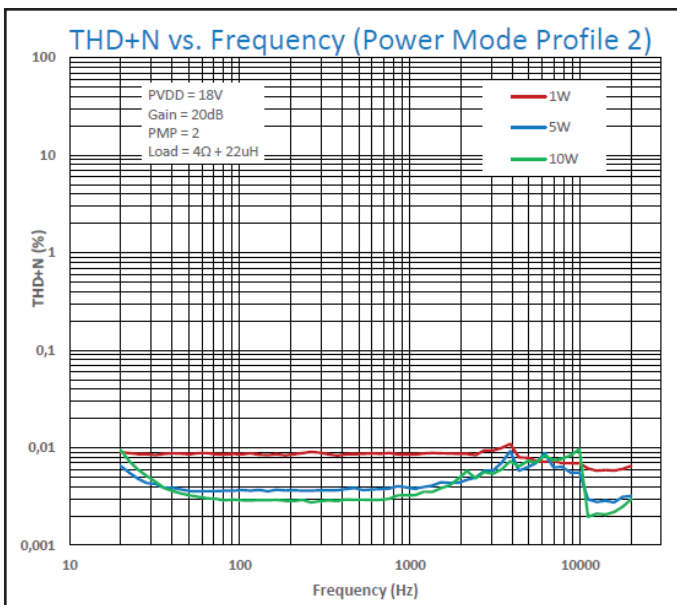

Figure 9: THD+N vs. frequency

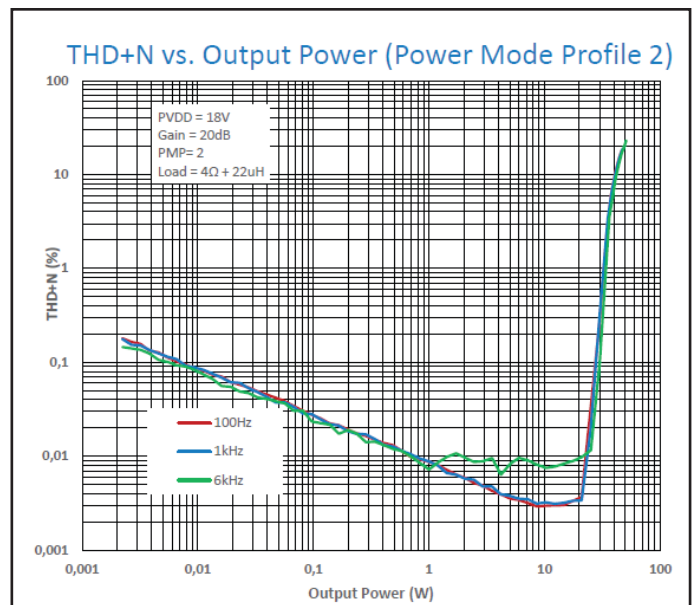

Figure 10: THD+N vs. output power

For battery-powered portable speakers, clearly power consumption is a key item. With the expected growth figures of this market segment a firm rise in demand of super-efficient Class-D amplification products can be expected as well. As audio quality is also becoming an important specification item, the new Infineon amplifiers are an extremely good fit for the most demanding applications, including the latest generation “smart speakers” (see **Figure 9** and **Figure 10**).

### The Products

Currently consisting of four products—the MA12040, the MA12040P, the MA12070, and the MA12070P—the Infineon multi-level amplifier series of products is able to improve designs in multiple segments, including soundbars, multiroom systems, hi-fi components, and commercial integration solutions, including networked speakers and modular amplifiers.

The “40” product range are 2x 40 W at 4 Ω using a 4 V to 18 V power supply, while the “70” products are 2x 80 W at 4 Ω with a 4 V to 26 V power supply. The “P” products have a digital I<sup>2</sup>S audio input instead of an analog input. All ICs support sample rates from 44.1 kHz to 192 kHz. A complete overview

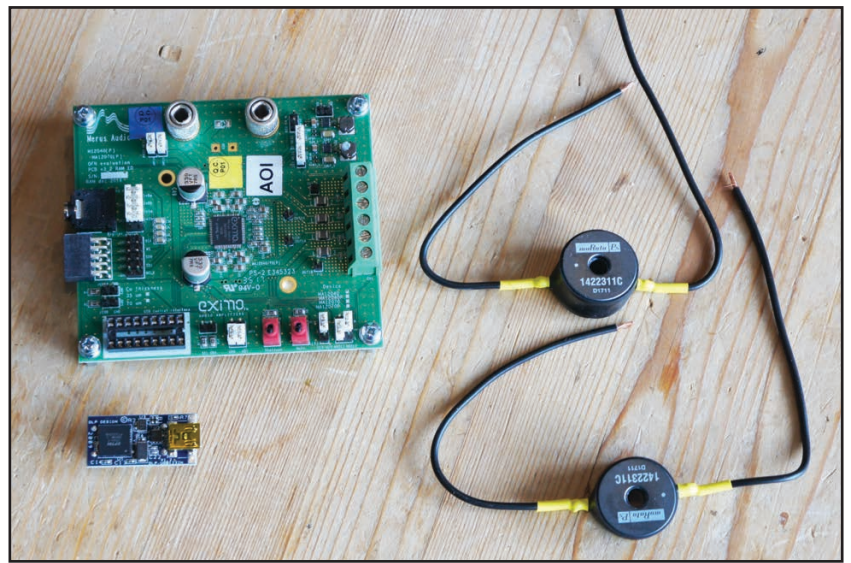

Photo 3: The original multi-level amplifier evaluation kit, created to support development with the new technology now acquired by Infineon.

can be found on the company’s website and in the Supplementary Material section of the *audioXpress* website ([www.audioXpress.com](http://www.audioXpress.com)).

For product development with multi-level amplifiers, there is a comprehensive evaluation kit (see **Photo 3**) which contains a variety of digital/analog input, output and setup/selection features. It



### Electronic Crossovers:

Solid State, Tube,  
Passive Line Level  
6,12,18,24,32,48 dB/octave  
Butterworth, Linkwitz-Riley, etc.

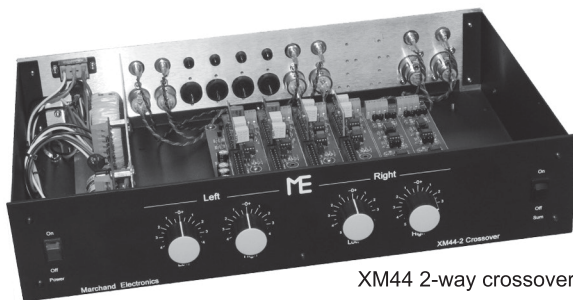

XM44 2-way crossover

### Custom Speaker Crossovers:

Potcore Inductors, Toroidal Inductors  
6,12,18,24 dB/octave

**Marchand Electronics Inc.**

(585) 423 0462 [www.marchandelec.com](http://www.marchandelec.com)

Ready, willing  
and

**AVEL**



offering an extensive range of ready-to-go  
**toroidal transformers**  
to please the ear, but won't take you for a ride.

 **Avel Lindberg Inc.**

47 South End Plaza, New Milford, CT 06776  
p: 860.355.4711 / f: 860.354.8597

[sales@avellindberg.com](mailto:sales@avellindberg.com) • [www.avellindberg.com](http://www.avellindberg.com)

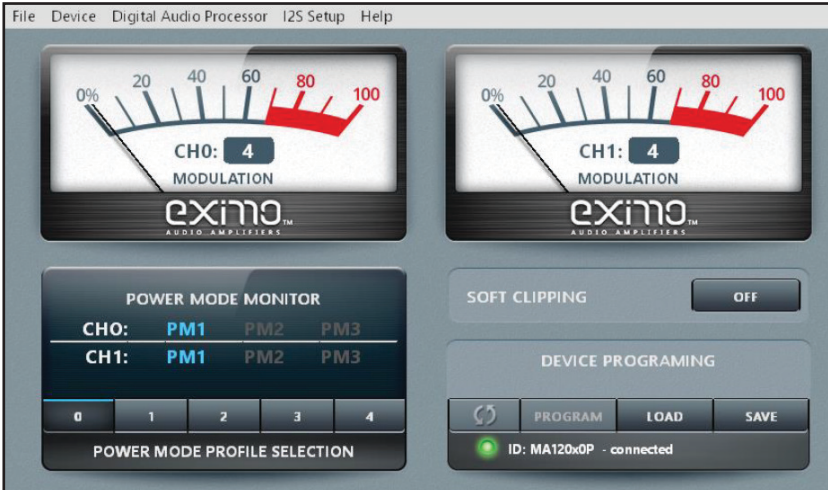

Figure 11: GUI of the evaluation kit, which is now being rebranded by Infineon.

also contains two on-board power supply generators (5 V and 3.3 V buck-converted), so only one external power supply (PVDD) is necessary. With this evaluation board, it is possible to verify the claims regarding energy efficiency, power losses at normal user operating conditions, idle power loss, the adaptive power management system, output filter components, solution cost, size reduction, and audio performance.

For ease of use, the evaluation board comes with an easy-to-use PC GUI to control and program the MA120xx device (see **Figure 11**). The Danish engineers also worked with Summit Wireless ([www.summitwireless.com](http://www.summitwireless.com)), Linkplay ([www.linkplay.com](http://www.linkplay.com)), and Eleven Engineering ([www.elevenengineering.com](http://www.elevenengineering.com)) on complete reference designs (see **Photo 4**), which can be used for new projects supporting wireless audio applications.

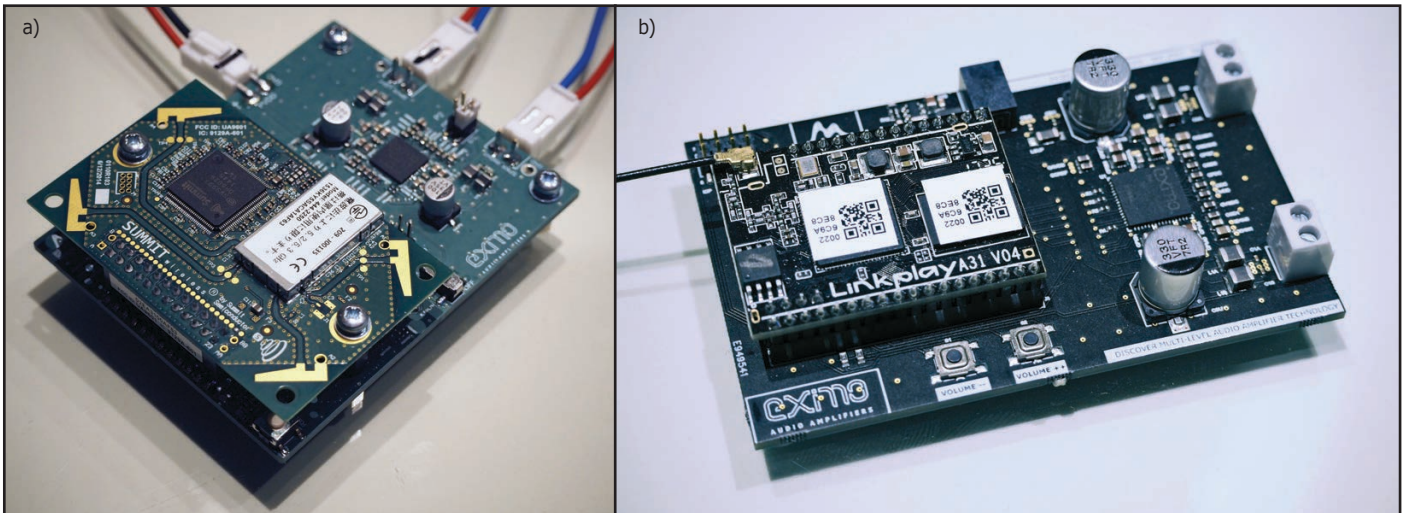

Photo 4: Reference designs for wireless audio products combining the original Merus eximo ICs with solutions from Summit Wireless (a) and Linkplay (b) as demonstrated at CES 2018.

## The Technology Founders

Prior to Merus Audio, Hans Hasselby Andersen was with Texas Instruments and with switching amplifier pioneer, Toccata Technology, holding various positions within R&D, business development, and product management. Before that, he was with Nokia Mobile Phones. Hans has an M.Sc.EE degree from the Technical University of Denmark and an Executive MBA from the Scandinavian International Management Institute.

Mikkel Høyerby was previously employed as a research engineer with Motorola in Copenhagen, working on RFP linearization, general RF/IF design as well as portable audio power amplification solutions. Mikkel received the M.Sc.EE degree in 2004 and the PhD degree in 2010 from the Technical University of Denmark. He currently holds two patents and has another four pending in the areas of switch-mode control and RFP linearization. Mikkel is a lecturer on the “Switch-Mode Audio Power Amplifiers (Class-D)” course at the Technical University of Denmark.



Hans Hasselby Andersen



Mikkel Høyerby



Photo 5: Merus Audio's suite at the Mirage Las Vegas, during CES 2018, promoted convincing demonstrations of the company's multi-level amplifier technology efficiency (a), including a retrofit on the existing Canton Musicbox S portable Bluetooth Speaker (b), extending the battery's duration 58%.

With these evaluation boards and reference designs, Merus Audio promoted very successful demos during CES 2018, in a hotel suite of the Mirage Las Vegas where delegations from most major consumer electronics manufacturers succeeded one after the other. While presentations were promoted in the main room and demo area, another room was used to holding meetings for potential customers and the room in the suite was used for more practical demos. In the bedroom, a modified Canton Musicbox S showed an increased battery life of 58% (**Photo 5**), taking the battery duration from 18 to 27 hours. No wonder the company became a target for an acquisition by a major semiconductor manufacturer.

On February 20, 2018, Infineon Technologies, the German semiconductor company, announced that it had acquired Merus Audio. The multi-level Class-D audio amplifier portfolio now complements Infineon's existing PowIRAudio product line for power levels below ~70 W and Infineon's existing sensor and audio processing solutions. Employees will remain in Copenhagen, Denmark, and are integrated into Infineon's existing audio business to become part of the Power Management & Multimarket Division. 

# hypex NCxxxMP series

## overview

The NCxxxMP amplifier module incorporates a low power standby power supply (meets 2013 ERP Lot 6 0.5W requirements), a highly efficient switch mode power supply and a high-performance Class D amplifier in one compact and easily applicable power brick.

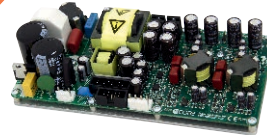

NC122MP

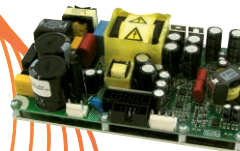

NC250MP

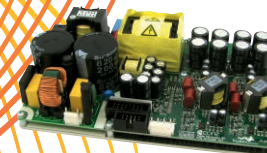

NC252MP

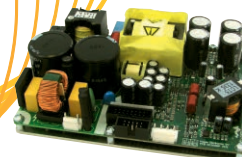

NC500MP



NC502MP

**Add-on Module NC100HF**  
The NC100HF is a dedicated tweeter-amplifier which fits the NCxxxMP series.



### Highlights

- High efficiency
- Universal mains operation
- Flat, fully load-independent frequency response
- Low output impedance
- Very low, frequency independent THD
- Very low noise

### Features

- One or two channel amplifier
- 5W standby SMPS
- Advanced over current protection
- External controlled operation
- Auto-switching (115/230V)
- Low weight
- Compact

### Applications

- Monitor loudspeakers for recording and mastering studios
- Audiophile power amplifiers for professional and consumer use.
- Public address systems
- Active loudspeakers

**ncore**  
audio power conversion

**hypex electronics**  
www.hypex.nl