

# Innovative Measurement Microphones from PCB Piezotronics



Photo 1: The 480M122 provides a 4 mA constant current for operation and amplifies the microphone preamp's signal. (Image courtesy of PCB Piezotronics)

Recently, I had the privilege to test a few of PCB Piezotronics professional-grade measurement microphones: the 378A04 free-field microphone, the 378B02 free-field microphone, the 378A21 diffuse-field microphone, and the 130E20 array microphone. Here are my findings.

By  
**Stuart Yaniger**

(United States)

A recurring theme in my test and measurement articles has been the 80/20 rule: 80% of the results come with 20% of the expenditure (or, equivalently, 80% of the cost is needed to get the last 20% of performance). And there's a lot of good low-cost options out there for hobbyist and casual designer use. But sometimes, you need a professional-grade instrument, especially for any task where there could be regulatory or compliance issues.

For professional acoustic measurement, there's a whole slew of choices. I have tended to stick with the tried and true, and in my day-job research, Brüel & Kjær has always been a reliable go-to, albeit an expensive one. But as a confirmed miser, I'm always on the lookout for alternatives that can deliver the same performance in a less costly package. So when I was contacted by PCB Piezotronics (Depew, NY) to check out four microphones in its professional line. I hesitated for about 3 nanoseconds before agreeing. The company sent me its ICP signal conditioner (see **Photo 1**) and four microphones—the 378A04 free-field microphone, the 378B02 free-field microphone, the 378A21 diffuse-field microphone, and the 130E20 array microphone (see **Photo 2**).

It's well known that technologies designed for top-of-the-line equipment often migrate down and improve the performance of lower-cost products.

What's interesting is when the opposite occurs—a less complex and expensive technology is optimized to punch out of its weight class. In this case, it's the upward migration of electret microphone technology to the hallowed halls where polarized condensers once ruled.

There are two basic technologies used for measurement (as opposed to recording) microphones: externally polarized condenser and self-polarized electret. Electret microphones dominate the low-end market, and many of them have been surprisingly good. An example popular with speaker hobbyists, dealers, and small shops is the Panasonic WM capsule series, most notably the WM-61A used in Joseph D'Appolito's Mighty Mike, as well as dozens of other similar projects.

The issues with inexpensive electret capsules have traditionally been noise, dynamic range, stability, and repeatability. However, their frequency responses can be reasonably consistent, and with regular calibration, they can cover a lot of measurement territory. Because of the favorable cost/performance tradeoffs, inexpensive electret capsules have become the basis of the latest generation of inexpensive and remarkably good-performing loudspeaker measurement gear.

Recognizing the limitations of this technology, a few people have tried improving the interface portion

of the inexpensive electret capsules—most notably Siegfried Linkwitz (a very simple modification that increases the dynamic range of inexpensive Panasonic mic capsules) and Scott Wurcer (a complete treatise on electret mic interfacing)—with great success. But to get the highest possible performance and measurement-grade stability, we need to use something better than low-cost capsules.

### Silk Purses From Coppa Piacentina

One way a serious measurement microphone can be distinguished from the available good-performing hobbyist microphones (which work great for basic speaker and room measurement) or most recording microphones is the use of higher quality, more stable materials. For example, most inexpensive microphones will use a metallized polyester film as a diaphragm.

The use of plastic for this component compromises temperature and humidity stability and measurement-to-measurement repeatability. This is less important for recording and basic speaker measurement, but for repeatable and traceable measurement, a more stable material (e.g., stainless steel) needs to be used. The tradeoff, besides cost, is mass, so a very thin (and expensive) foil needs to be used, which was PCB Piezotronics' choice.

There's a range of electret materials. The best and most expensive microphones show high stability with varying temperature and humidity and are also highly stable over time, which is a significant factor at the price levels commanded by measurement microphones.

PCB Piezotronics was reticent to reveal which electret material it uses, and since these microphones were on loan and not inexpensive, I demurred on disassembly and analysis! If I were to guess, it would be an ion-implanted fluoropolymer, due to the excellent thermal stability and high resistivity, but this is sheer speculation.

**Figure 1** shows a diagram of the PCB Piezotronics capsule construction (self-polarized) contrasted with a condenser capsule (externally polarized). Another way in which lab-grade measurement microphones differ from conventional recording or inexpensive measurement microphones is the method of getting the signal from the diaphragm to a voltage and current level compatible with measurement inputs (e.g., analog-to-digital-converter cards).

Conventional electret capsules generally require a DC voltage of typically 5 to 15 V to power their on-board circuit (usually a source follower). Condenser microphones are generally balanced output and use an external polarization voltage from 48 to 200 V.

PCB Piezotronics developed an interface method using a current source rather than a voltage source, called ICP. The advantages of ICP include compatibility



Photo 2: The four PCB Piezotronics microphones that I tested vary in size. (Photo courtesy of Cynthia Wenslow)

with all measurement products in the PCB Piezotronics line, simple and inexpensive interface circuitry, and coaxial-based input and output connections. Many laboratory and industrial data acquisition cards have constant current input capability, so the ICP microphones can be used directly with their inputs. The PCB Piezotronics microphones all attach to a mount or stand via a 0.5" diameter clip, available as an accessory.

### Interfacing: 480M122 ICP Signal Conditioner

The 480M122 signal conditioner comes in solid but fairly plain packaging and it takes three standard 9 V batteries for power. Note that although the faceplate for the unit in the photo shows a different model number (480E09), the bar code serial number indicates the '122, which is identical to the '09 except for a higher guaranteed current (4 mA vs. 2mA).

The meter indicates battery condition or transducer status (charge and connection) and the unit's input provides the 4 mA constant current required by all the non-condenser microphones and other transducers in the PCB Piezotronics line. Gain is adjustable to be  $\times 1$  (0 dB),  $\times 10$  (20 dB), or  $\times 100$  (40 dB), and input and output connections are standard BNC, which is convenient for most auxiliary test equipment.

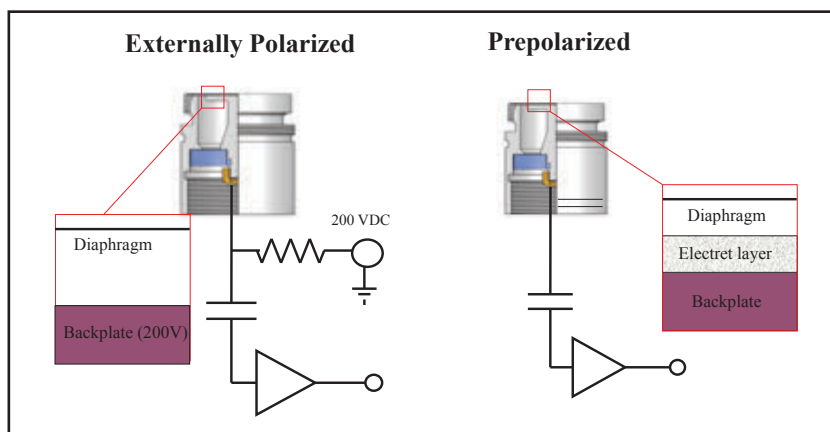

Figure 1: The difference between an externally polarized vs. self-polarized microphone is the source of the DC when the diaphragm is at rest.



Photo 3: The 378A04, a 0.5" self-polarized microphone, features exceptionally low noise and high output. (Image courtesy of PCB Piezotronics)

**Figure 2** shows the conceptual schematic. An inspection of the innards shows it to be not much simplified from the real circuit. It comprises a constant current diode, a battery pack, and a switchable gain voltage amplifier. The constant current supply (CCS) diode acts as a remote drain load for the field-effect transistor (FET).

This signal conditioner was used for all microphone testing described here, and the output was connected to the input of my M-Audio Delta 192 sound card. For software, I used a Virtins Multi-Instrument and ARTA, with calibrations of the inputs performed at each startup. The 480M122 performed silently and flawlessly throughout all of the testing. It might not look as cool as a fancier microphone signal conditioner, but it costs a small fraction of the lab preamp I used for comparison and was never the limiting factor in any measurements. Retail price for the 480M122 is \$375.

### 378A04 Free-Field Microphone

I will be a bit lengthier in my exposition here than for the other PCB Piezotronics products. I am doing so because some methodology common to all my measurements needs to be explained, because there are technological aspects here common to the other PCB Piezotronics microphones, and because this is perhaps the most interesting product of the four microphones that I have on hand.



Photo 4: The BLANK method of noise floor measurement involves wrapping the microphone in plastic and duct tape to protect it, then burying in a mixture of sand and cat litter.

The 378A04 is a 0.5" self-polarized microphone (see **Photo 3**). It features exceptionally low noise (A-weighted noise rated at a remarkably low 5.5 dB SPL typical, referenced to a standard 20  $\mu$ Pa level) and high output (typically 450 mV/Pa). Typically, noise this low is only found in microphones with larger diaphragm sizes (self-noise scales roughly as the inverse square of diameter), with the tradeoff being a reduced frequency at which lobing and increased directionality start becoming significant. This microphone also features Transducer Electronic Data Sheet (TEDS) IEEE P1451.4—an on-board chip that identifies the particular microphone being used by serial number. When read by a TEDS-compliant preamplifier or data acquisition system, it can also detect the calibration information.

The pattern is free-field, so this microphone is most suited for measurements of single sources in a largely non-reverberant field. The individual and serialized two-page calibration sheet included with the microphone indicates a microphone sensitivity of 473.29 mV/Pa with an inherent noise of 5.07 dB. The calibration sheet also includes free-field frequency response measured anechoically, shown graphically and as a table displaying frequency (1/12 octave spacing) and magnitude (to 0.01 dB precision).

As part of the traceability standards, reference equipment, calibration data, measurement procedures, and all document control indications are also included. The price of the capsule plus the preamp body is \$2,200.

Noise measurements at that low of an equivalent SPL are not trivial. Even with a high-quality anechoic chamber, which I do not have, getting a background noise level significantly below the 5.5 dB rating of this microphone is a difficult task. In my basement lab, during the stillest of nights, and surrounded by every blanket and towel I could muster, I couldn't get below 20 dB. Besides the ambient noise, it is easy to ruin a measurement just from the vibration of the microphone-to-preamp cable, as well as electrical noise pickup. So, as usual, we have to substitute resourcefulness for resources.

Following a hint from Scott Wurcer, and furiously improvising, I set up my Basement Lab Ambient Noise Killer (BLANK) chamber, using the finest of duct tape, inexpensive storage bins, plastic bags, kitty litter, and sand. **Photo 4** shows the idea: I wrapped the microphone in a plastic food storage bag (Glad), then wrapped the bag and microphone in duct tape in the manner of an impoverished Pharaoh's mummified corpse. Then, I buried the microphone mummy in about 150 lbs of a mixture of veterinary vermiculite (Fresh Step) and sand (Sakrete) in a large plastic storage bin. I placed half the sand/vermiculite in

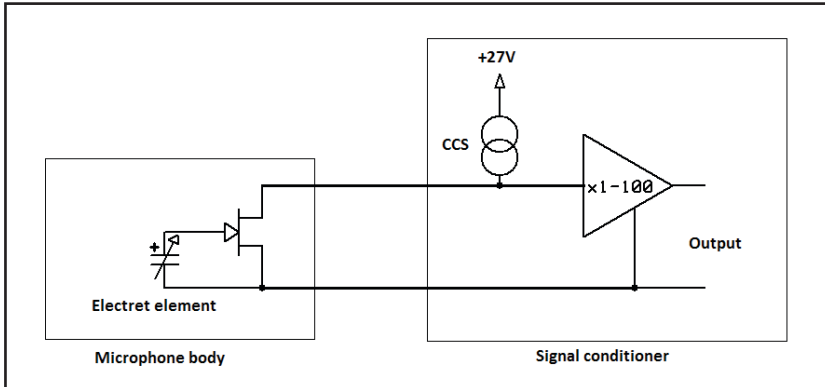

Figure 2: A functional schematic of the microphone and the interface for PCB Piezotronics' self-polarized microphones and constant current supply shows the simplicity of this system.

the bin, placed the mummy on top, and poured the other half of the sand/vermiculite in over the mummy effecting its burial. I filled the inch or so gap between the lid and the top of the sand mix with rags, and ran the cable out through a hole in the top, gasketed by an old sock. I kept the cable between the microphone and preamp as short as possible (under 2') to minimize vibration, and suspended it off the basement floor using more wadded-up rags. I then covered the entire chamber and preamp with a pile of acoustic blankets. In the interest of full disclosure, although I would love to say that I thought of the entire thing at once, I must admit that each of these steps was

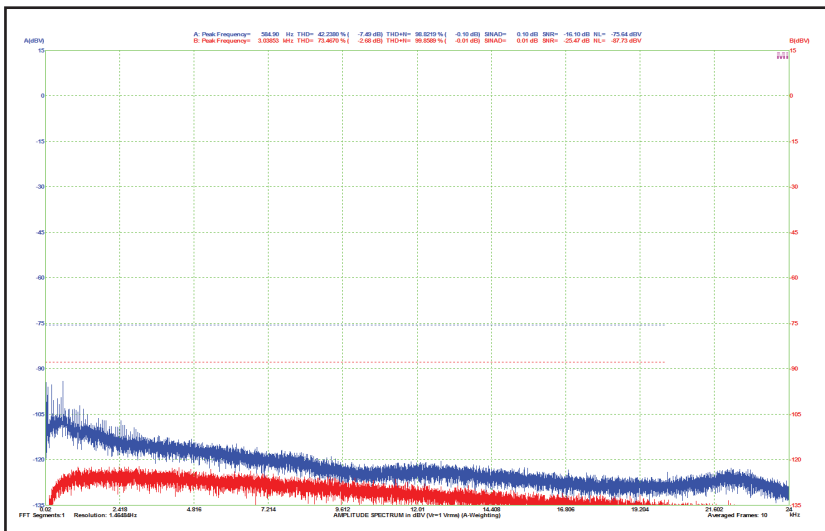

Figure 3: The noise spectrum of the 378A04 microphone amplified by 20 dB confirms the remarkably low noise specification. The top (blue) trace is the microphone. The bottom (red) trace is the measurement system noise floor.

## About the Author

Stuart Yaniger has been designing and building audio equipment for nearly half a century, and currently works as a technical director for a large industrial company. His professional research interests have spanned theoretical physics, electronics, chemistry, spectroscopy, aerospace, biology, and sensory science. One day, he will figure out what he would like to be when he grows up.

taken sequentially, with measurements confirming that there was a reduction in the microphone output with each "improvement."

As an aside, I should mention that I tried a very thin cable using PTFE dielectric with the idea that increased flexibility should result in lower vibration pickup. Unfortunately, this turned out poorly, but I now know a novel way to make a vibration sensor. I don't know what was to blame, the increased triboelectric potential or the lowered wire-to-shield rigidity of PTFE, but there was no question that the conventional coaxial cable performed better.

I set the preamp for a gain of  $\times 10$  (20 dB) to make sure that the microphone, rather than the preamp, set the noise floor. I ran it into the line-level input of my sound card (M-Audio Delta 192), and measured using the A-weighted noise function of the Virtins Multi Instrument software set for a 20 Hz-to-20-kHz bandwidth.

Figure 3 shows the noise spectrum, with the mic channel in blue and the (open circuit input) unused channel shown in red as a reference. A-weighted noise was calculated at -75.64 dBV. The noise floor calculation is then simple: the microphone's output at 1 Pa (94 dB) is -6.5 dBV. There's 20 dB gain in the signal conditioner, so the noise referenced to 0 dB (20  $\mu$ Pa) is 4.86 dB. This is a bit lower than the rated noise, but the noise rating is determined at 74°F (23°C), whereas my basement lab is about 58°F (14.4°C). Lower temperatures generally mean lower noise, so this is possibly one source of this minor (0.7 dB) discrepancy. Likewise (and perhaps more importantly), for the equipment used in this measurement (the sound card and the Multi Instrument software), my calibrations are good, but perhaps not to perfectly NIST-traceable standards. Either way, for a 0.5" microphone (the largest diameter suitable for normal audio range measurement), this is a very quiet microphone!

This noise exposition was a bit long, but I think that this is a useful and low-cost method that can be used by hobbyists or small businesses to measure microphone noise without having a specialized chamber. Likewise, each of the isolation steps I took was validated by the microphone, so if I were really trying to hush a room or silence a piece of machinery, I would absolutely choose this microphone.

The tradeoff for the low noise is limited high SPL capability. For this microphone, the distortion specification of 3% total harmonic distortion (THD) is met at 80 dB (20  $\mu$ Pa), broadband, and 100 dB when bandwidth limited to under 5 kHz. Even if this specification is conservative, this is a disqualifier for typical loudspeaker or industrial machinery measurement. Fortunately, the SPL rating before damage is greater than 130 dB, so the accidental loud

noise is unlikely to shatter anything. Purely speculation on my part, but this is another factor that suggests that one of the tricks to achieve this impressively low noise and high sensitivity is lower tension on the diaphragm, and thus, greater travel for a given impinging pressure.

I used a Brüel & Kjær 4231 calibrator with a 0.5" adapter, set to at 94 dB (20 µPa), and a 1 kHz excitation frequency to check the sensitivity. I measured 492 mV with the interface box set to x1 gain. This varies from the calibration sheet by 0.3 dB, well within the error limits of the calibrator and PCB Piezotronics' measurement. The distortion might also lead to a slightly higher than rated number.

I measured the frequency response by comparing it to a reference microphone. Since I don't have an anechoic chamber at my disposal, I used a gated response before the first reflections (quasi-anechoic). This limits low-frequency data, so I show response only above 1 kHz. The frequency response shown in **Figure 4** is within 0.5 dB of the calibration data supplied by PCB Piezotronics.

**Figure 5** shows the polar pattern data from PCB Piezotronics' anechoic chamber. The microphone is nearly omnidirectional at low frequencies, with increasing directionality at higher frequencies because of the microphone geometry. The usual setup suggestions for non-reverberant measurement apply here—the microphone should be pointed directly at the source so that the high frequencies can be added with correct amplitude. Note the absence of lobing and the smooth transition in directionality with increasing frequency, both of which are necessary for accurate free field measurement.

PCB Piezotronics will be glad to hear that I didn't perform the IEC 60068-2-31 test, which calls for dropping the microphone onto a hard surface from a 1 m height.

### 378B02 Free-Field Microphone

A more general-purpose 0.5" test microphone will have a higher noise floor than the 378A04, but will also be able to measure at higher SPLs. In the case of the 378B02 (see **Photo 5**), the maximum sound pressure is 138 dB, which will allow its use in near-field measurement. Noise floor is specified as less than 18.5 dB, which is pretty much average for the genre. The 378B02 comprises a 377B02 capsule and a 426E01 preamplifier/mic body. Retail price for this combination is \$1,040.

On test, the noise floor—determined by the BLANK method I described earlier—easily met specification, clocking in at a moderately quiet 15.1 dB, A-weighted, well under the specified 16.5 dB(A) maximum. **Figure 6** shows the measured frequency response above 1 kHz,

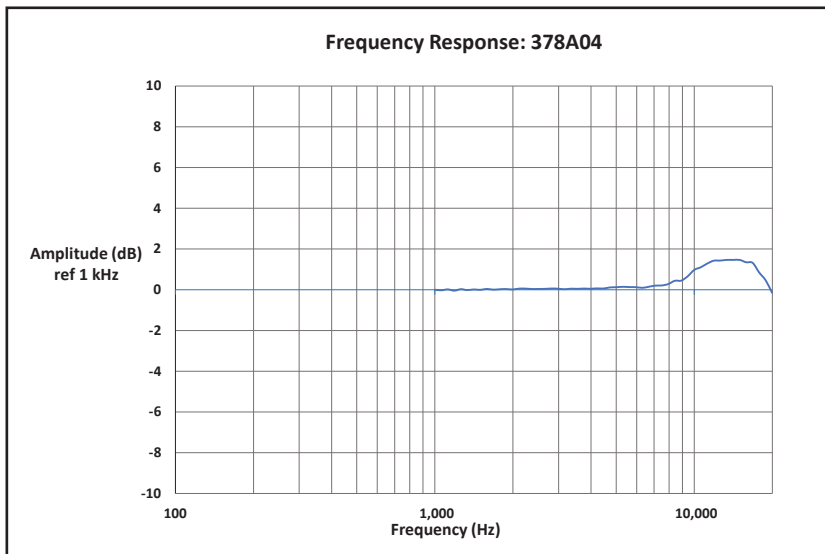

Figure 4: The frequency response of the 378A04 was determined by comparison to a reference microphone. Frequencies below 1 kHz have been cut to account for the removal of reflections.

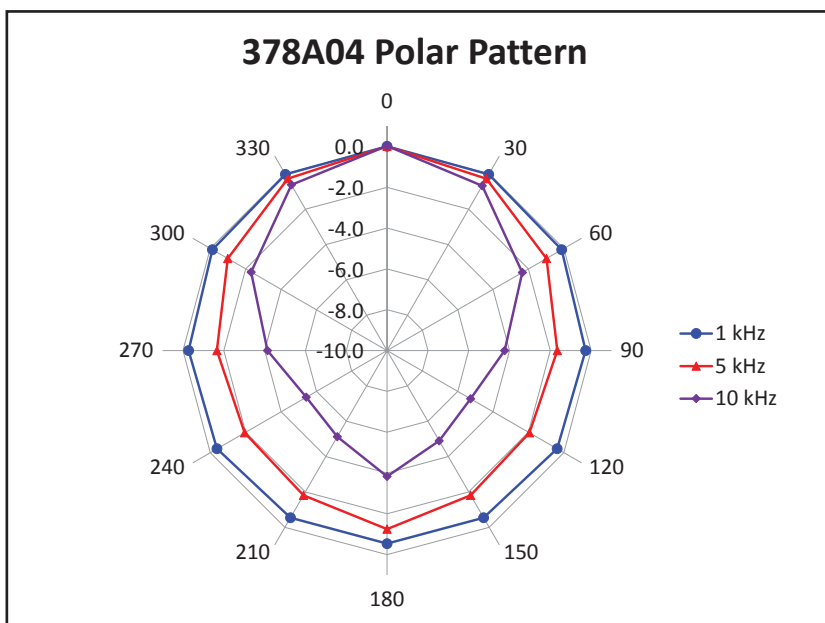

Figure 5: The polar pattern of the 378A04 measured in PCB Piezotronics' anechoic chamber shows a smooth narrowing of the directivity with increasing frequency.



Photo 5: The 378B02 0.5" free-field microphone looks well-suited to precision loudspeaker or other acoustic transducer measurement. (Image courtesy of PCB Piezotronics)

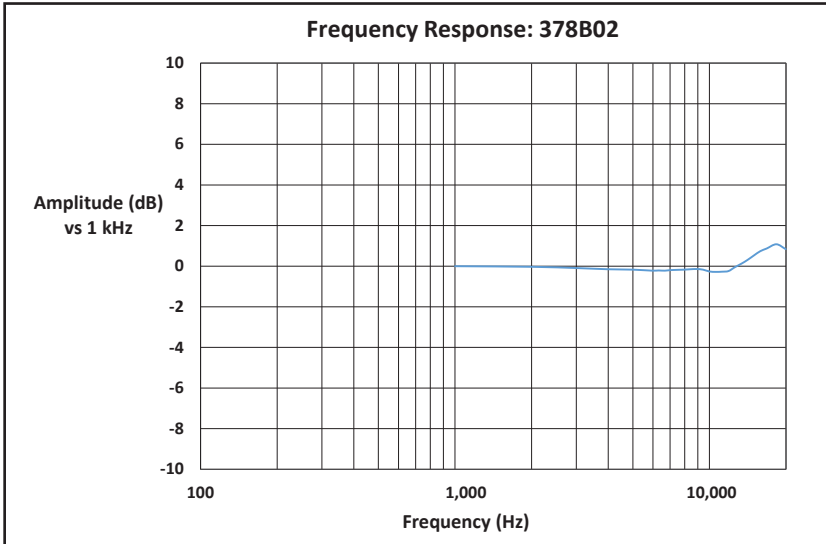

Figure 6: The frequency response of the 378B02 was measured by comparison to a reference microphone and conforms closely to the supplied calibration curves.



Photo 6: The 378A21 0.5" diffuse-field microphone looks like a great choice for measuring explosions, gunshots, or space shuttles, thanks to the microphone's remarkable 160 dB, 3% distortion limit. (Image courtesy of PCB Piezotronics)

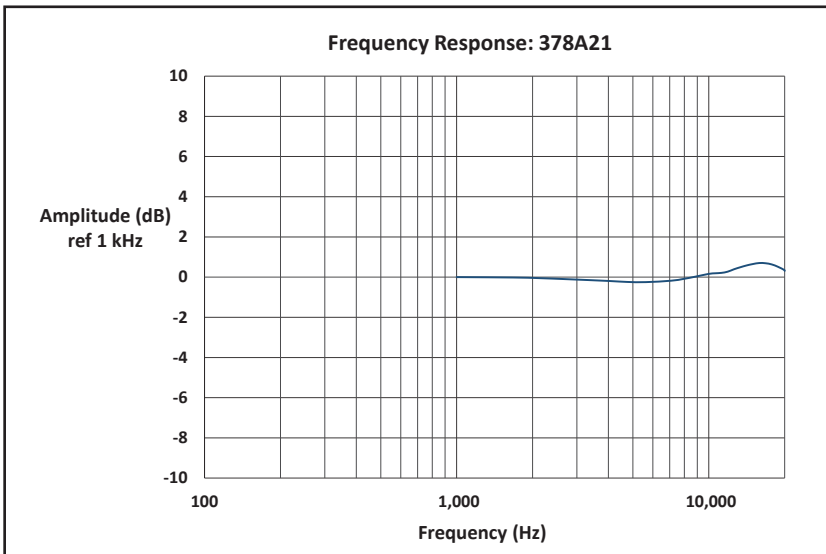

Figure 7: The frequency response of the 378A21, obtained by comparison to a reference microphone, shows excellent conformance to calibration values.

and is within 0.4 dB of the calibration sheet data. Sensitivity at 94 dB SPL (1 Pa) measured 48.5 mV, within measurement error of the supplied calibration. This microphone is suited to precision loudspeaker or other acoustic transducer measurement.

### 378A21 Diffuse-Field Microphone

The 378A21 0.5" diffuse-field microphone is set up for diffuse-field measurement (i.e., in a reverberant field with sound impinging from multiple sources). It comprises a 377A21 capsule and a 426E01 preamplifier/mic body (see **Photo 6**). Typical applications are sound reinforcement measurement and measurement of noise levels in a factory or other work environment. The specialty of the 378A21 is very high sound levels—its rated 3% distortion point is 147 dB SPL minimum and that's limited by the preamp. The microphone itself is rated to 160 dB SPL. I am simultaneously abashed and relieved that I was unable to test that limit.

What I did instead was check it in a reverberant room with two speakers playing uncorrelated white noise at about 90 dB SPL. **Figure 7** shows the frequency response taken with the microphones at a 70° measurement angle.

Sensitivity measured 11.8 mV/Pa, a bit below the rated 12.08 mV/Pa, but within measurement tolerance. The noise floor measured with the BLANK method was 21 dB, A-weighted, so this would not be the first choice for low noise applications.

However, this looks like a great choice for measuring explosions, gunshots, or space shuttles, thanks to the remarkable 140 dB between the noise floor and the 3% distortion limit. Retail price for the microphone (capsule plus preamp/body) is \$1,100.

### 130E20 Array Microphone

Microphones yield data at a single point in space, so multiple measurements are needed if you want to map out an acoustic source. Generally, there are two ways to do this—move the microphone to get data at multiple positions (which only works for steady-state signals) or construct an array of microphones to simultaneously measure at multiple points. The latter method is a powerful means of characterizing both spatial and frequency distribution of a sound source and has found use in sonic holography and sound intensity mapping.

The obvious disadvantage of this method is cost. For a 4x4 array of microphones plus the necessary 16 channels of signal conditioning, a test lab would have to lay out something on the order of \$50,000. For this specific application niche, PCB Piezotronics makes a smaller less expensive model, the 130E20 0.25" electret array microphone (see **Photo 7**).

The microphone is only 2.6" long, which helps reduce mass and size in an array configuration. Retail price for the 130E20 (which includes a capsule and a preamp) is \$295, significantly lower than the lab microphones, while still offering individual calibration, high stability, and traceability. Like its bigger and more expensive brethren, the 130E20 is TEDS-compliant. Given the likely applications (acoustic mapping), the pattern for these microphones is free-field. The specified noise floor is 30 dB, A-weighted, about the same noise as a very quiet residential room. Maximum SPL is rated at 122 dB at 3% distortion. Sensitivity is rated at 45 mV/Pa (-29.6 dB).

According to the calibration sheet, the sensitivity of my particular unit was -42.7 mV/Pa (-27.4 dB). Unfortunately, I could not verify the sensitivity since my calibrator does not have a 0.25" adapter. But based on an in-room comparison with the 378B02, that value seems about right. **Figure 8** shows the measured frequency response, which closely compares to the supplied response on the calibration sheet. Noise level using the BLANK method was 28.5 dB, A-weighted, compared to the specified 30 dB maximum.

### Wrap-Up

I've been fortunate to have used some fine test microphones over the years, and even more fortunate to have a few of them at my disposal for day-to-day test and measurement use. These are the first professional-grade measurement microphones using current source interfacing that I've used in my home lab. Despite the simplicity and reduced cost compared to conventional condenser microphones, they performed flawlessly, effortlessly, and reliably. Interfacing and setup were simple, painless, and reliable.

The provided documentation was Spartan in appearance, but complete and informative—a model of what test and measurement documentation should be. Methods, calibration, and traceability are complete and traceable to NIST standards, which is one of the things you're paying for in a lab-grade microphone. Likewise, the packaging was plastic boxes and foam, rather than something that looks like a Zero Halliburton case, but what's inside is first-rate. PCB Piezotronics has concentrated on the function, not the facade.

Where I might suggest improvement is in the format for the documentation: It would be nice if all calibration information was provided either as a downloadable digital file or on a thumb drive so it can be directly imported into programs (e.g., Excel). With TEDS-compliant interfaces, this is less of an issue, and when I requested the data in digital format, PCB Piezotronics quickly provided it for me. Bottom line: Packing these microphones up for their return was a traumatic experience for me. 📦



Photo 7: The 130E20 0.25" array microphone offers individual calibration, high stability, and traceability. (Image courtesy of PCB Piezotronics)

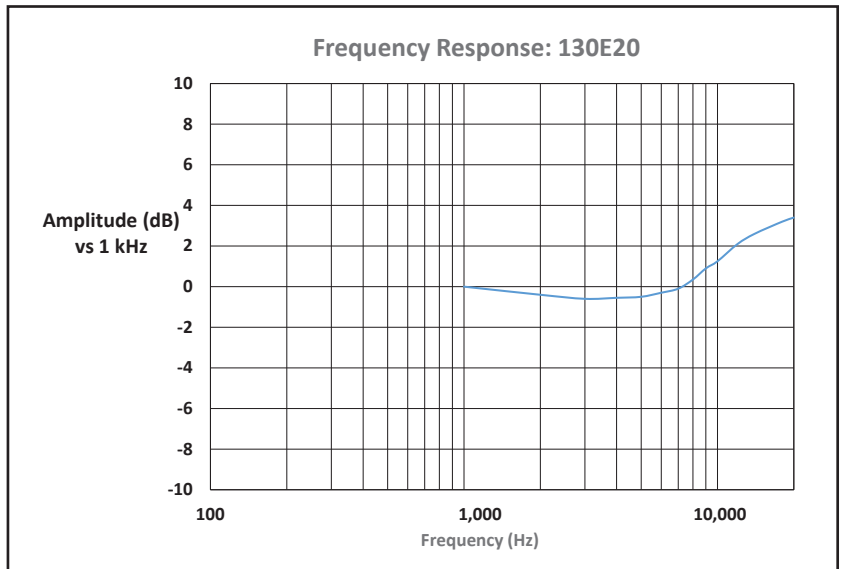

Figure 8: The frequency response of the 130E20 array microphone was measured by comparison to a reference microphone and conforms closely to the supplied calibration curves.

### Resources

*Microphone Handbook*, PCB Piezotronics, [www.pcb.com/microphoneHandbookFiles/microphone\\_handbook\\_lowres.pdf](http://www.pcb.com/microphoneHandbookFiles/microphone_handbook_lowres.pdf).

S. Wurcer, "DIY Low Noise Microphone Preamplifiers: Part 1" *Linear Audio*, Volume 1 (available at [www.linearaudio.net](http://www.linearaudio.net)).

——, "DIY Low Noise Microphone Preamplifiers: Part 2" *Linear Audio*, Volume 3 (available at [www.linearaudio.net](http://www.linearaudio.net)).

### Sources

**4231 calibrator with a 0.5" adapter**  
Brüel & Kjær | [www.bksv.com](http://www.bksv.com)

**M-Audio Delta 192**  
M-Audio | [www.m-audio.com](http://www.m-audio.com)

**Virtins Multi Instrument software set**  
Virtins Technology | [www.virtins.com](http://www.virtins.com)